

SPECIFICATIONS
 Voltage Rating: 250V AC/DC
 Current Rating: 3A AC/DC
 Withstanding Voltage: 1500V AC/minute
 Insulation Resistance: 1000MΩ min.
 Temperature Range: -40° C - +105° C
 Contact Resistance: 20mΩ max

WAFER
 Part No: SCT2544WR-XXPC
 Poles: 2-25
 Material: PBT+GF15%
 Pin: Brass/Gold plated

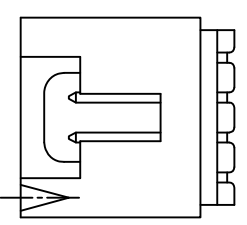

PART NO.	Dimensions			
	A	B	C	D
SCT2544WR-02PC	7.37	5.33	2.54	
SCT2544WR-03PC	10.17	8.13	5.08	7.70
SCT2544WR-04PC	12.71	10.67	7.62	10.24
SCT2544WR-05PC	15.25	13.21	10.16	12.78
SCT2544WR-06PC	17.79	15.75	12.70	15.32
SCT2544WR-07PC	20.33	18.29	15.24	17.86
SCT2544WR-08PC	22.87	20.83	17.78	20.40
SCT2544WR-09PC	25.41	23.37	20.32	22.94
SCT2544WR-10PC	27.95	25.91	22.86	25.48
SCT2544WR-11PC	30.49	28.45	25.40	28.02
SCT2544WR-12PC	33.03	30.99	27.94	30.56

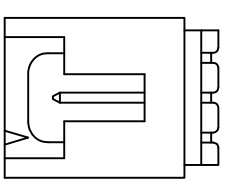
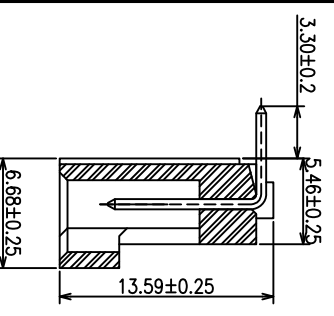
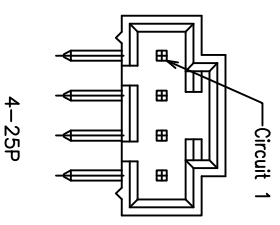
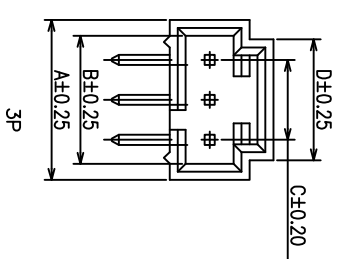
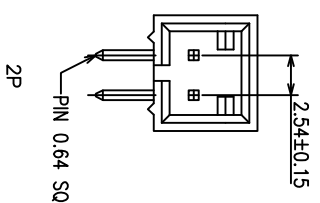
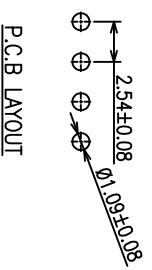

OPERATION		~ 10	±0.15	DRAW	YANG	2016.05.11	SCALE	森康达电子有限公司 SCONDAR ELECTRONIC LIMITED		
DESIGN		20 ~ 30	±0.30	CHECK	MICKY	2016.05.11	UNIT	A4	PART NO.	SCT2544WR-XXPC
CHECK		30 ~	±0.50	APPROVE	ALLEN	2016.05.11	SIZE	1/1	TITLE:	MX2.54 CD-ROM 90C WAFER
REV	DATE	MODIFICATION DESCRIPTION	CHANGE	APPROVE			SHEET		DRAWING NO.	SCT2544
0	05/12/27	NEW					PROJ.			

1 2 3 4 5 6 7 8 9 10